

Article number: 203180M1043B2X

Description: E+G levelling foot

GN 31-80-M10-43-B2-X

Note: X With female thread, External hexagon

## Measures

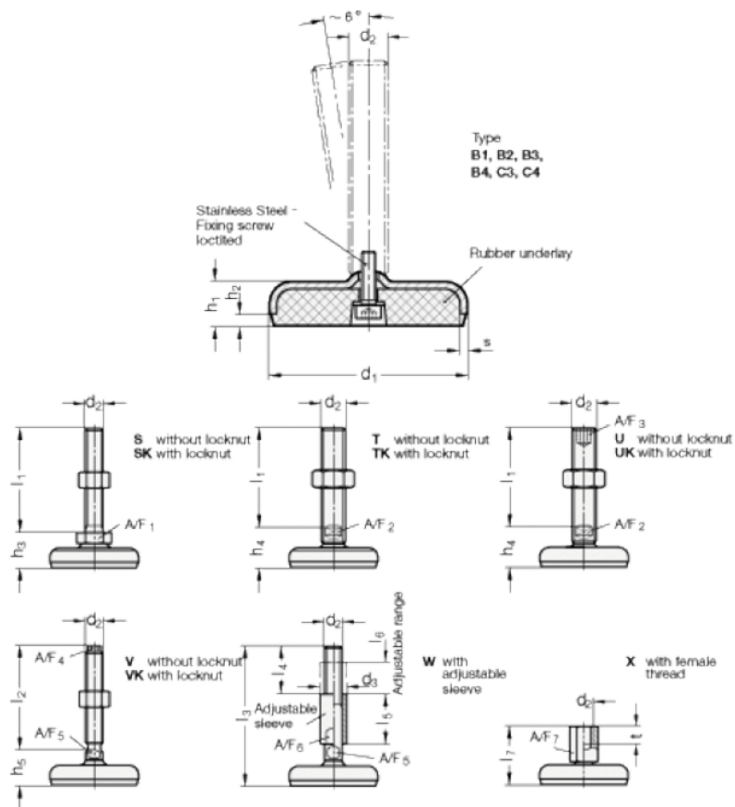

A/F7	= 14
d1	= 80
d2	= 10
h1	= 18
h2	= 5
l7 +4.0/0	= 43
s	= 3
t	= 10